



BAD BOY GRASS BAGGING SYSTEM

TABLE OF CONTENTS

WILL FIT ALL 2019 OUTLAW SERIES MOWERS

SAFETY RULES AND INFORMATION.....	2
GENERAL OPERATION.....	3
WARRANTY INFORMATION.....	5
INSTALLATION INSTRUCTIONS.....	6





SAFETY RULES & INFORMATION



Read these safety rules and follow them closely. Failure to obey these rules could result in loss of control of unit, severe personal injury or death to you, or bystanders, or damage to property or equipment.

This mowing deck is capable of amputating hands and feet and throwing objects. The triangle in text signifies important cautions or warnings which must be followed.

GENERAL WARNINGS

- Know the mower controls, safety rules and how to stop quickly. **READ AND UNDERSTAND THE MOWER OPERATOR'S MANUAL.**
- Read and obey all safety decals.
- Wear appropriate ear, eye and breathing protection.
- Only allow responsible adults, who are familiar with the instructions, to operate the unit.
- Disengage the electric clutch (PTO). Shut off the engine and wait for all moving parts to stop before attaching, adjusting, or disconnecting any part of the collection system.
- Check the collection system to make sure it is bolted tightly to the Mower.
- **DO NOT** operate the mower without either the entire grass catcher or the deflector in place.
- Turn off the PTO switch to disengage the blades when not mowing.
- **DO NOT** mow in reverse. Always look down and behind before and while traveling in reverse.
- **DO NOT** turn sharply when traveling alongside a building or any object. Slow down before turning.
- **DO NOT** carry passengers on the rider.
- When blower assembly is removed from the mower deck, the discharge chute must be properly installed.
- Collector bags are subject to deterioration and wear during normal use. Inspect the bag periodically for tears, holes or weak spots and replace with a new bag that meets manufacturer's durability standards.
- If the mower stalls or blower chute plugs:
 1. Disengage the electric clutch (PTO);
 2. Stop the engine and remove the key;
 3. Set the parking brake, and wait for all moving parts to stop.
 4. Remove the foreign object or clear the chute with a piece of wood before restarting the engine. **NEVER place hands into blower housing to clear jammed object. Blower may rotate when object is removed.**
- For added rider stability and to prevent tipping or loss of control:
 - a. Use reduced speed on uneven ground and when turning corners.
 - b. Reduce loads on hillsides. It is recommended that the collection system be kept no more than half full when negotiating any slopes. Start mowing on slopes when the collection system is empty.
 - c. Mow across the face of slopes: not up and down.
 - d. If provided counter weights must be properly installed prior to using the grass collection system.

- **Never operate on slopes greater than 17.6% (10°).**



SAFETY DECALS

This unit has been designed and manufactured to provide you with the safety and reliability.

Although reading this manual and the safety instructions it contains will provide you with the necessary basic knowledge to operate this equipment safely and effectively, we have placed several safety labels on the unit to remind you of this important information while you are operating your unit.

All DANGER, WARNING, CAUTION and instructional messages on your bagger should be carefully read and obeyed. Personal bodily injury can result when these instructions are not followed. The information is for your safety and it is important! The safety decals below are on your bagger.

If any of these decals are lost or damaged, replace them at once. See your local dealer for replacements. These labels are easily applied and will act as a constant visual reminder to you, and others who may use the equipment, to follow the safety instructions necessary for safe, effective operation.

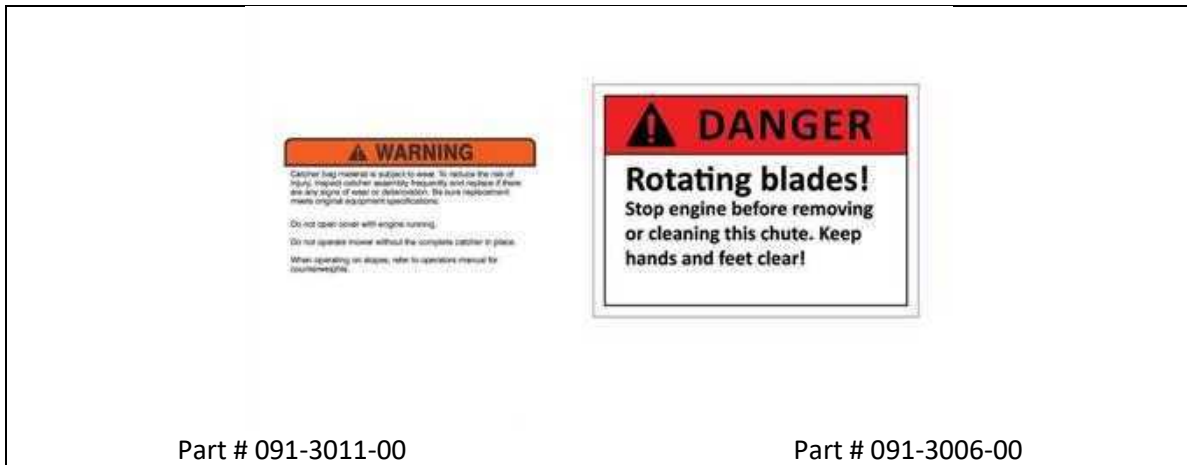

GENERAL OPERATING INSTRUCTIONS

BEFORE OPERATION

Clear the lawn of all sticks, stones, wire and other debris which may be caught or thrown by the mower blades.

Check grass condition. If wet, wait until later in the day. If grass is wet, the grass catcher is likely to become plugged.

For efficient bagging, air circulation under the mower deck, through the chute and into the bag is very important.

For this reason, BEFORE YOU BEGIN MOWING you should make certain the underside of the mower and the underside of the catcher lid are free from grass and debris.

Make sure that there is a snug fit between mower deck, blower housing, tubes, and grass catcher cover.



MOWING WITH YOUR BAGGER

Always operate with throttle at full speed when mowing.

Always wear hearing protection when operating grass catcher.

Grass should be cut often, and not too short. If grass is too long or lush it may be necessary to keep ground speed to a minimum or to cut only half the width of the mower to prevent clogging. If grass is long, operate with mower in high cutting position for first pass, cutting again in a lower position on a second pass.

Do not open the cover with mower engaged.

If a large amount of cut grass is spilling out from under deck, the tube may be plugged or the bags may be full— discontinue mowing, stop the mower, disengage the PTO and then empty the catcher or clear the tube.

● **WARNING**

ALWAYS shut off the mower. Disengage the PTO, and allow all moving parts to stop BEFORE disconnecting or clearing tube, or emptying catcher.

Before leaving the operator's position for any reason, engage the parking brake, disengage the PTO, stop the engine and remove the key.

To reduce fire hazard, keep the engine, rider and mower free of grass, leaves and excess grease. Do not stop or park rider over dry leaves, grass or combustible materials.

AFTER OPERATION

Remove any debris from the screen on the under- side of the lid. *Note: The lid screen can be removed for easier cleaning and should be cleaned regularly.*

The blower housing and tube should be removed for cleaning.

Inspect the grass bags for wear or damage. Make sure that there is a snug fit between mower deck, blower housing, tubes, and grass catcher cover.

STORING THE GRASS CATCHER

Clean the grass catcher thoroughly using a mild detergent (other products may damage the tube). Remove any debris from the screen on the underside of the lid. The screen can be removed for easier cleaning.

If paint has been scratched on metal parts, touch up with paint, or apply a thin film of oil to prevent corrosion.

Store in a dry area. Hang the catcher and catcher bags to dry thoroughly before storing for a long period of time.

Always store away from moisture.

MOWING WITHOUT THE BLOWER

For operation without the blower, the discharge chute must be properly installed.



WARRANTY

OWNER/OPERATOR'S RESPONSIBILITY

It is the owner and/or operator's responsibility to read the owner's manual before use. Failure to read the owner's manual is considered a misuse of this equipment.

It is the owner and/or operator's responsibility to inspect the product and to have any part(s) repaired or replaced before continued operation. Failure to do so could cause damage, excessive wear to other parts, or jeopardize operator safety.

LIMITED WARRANTY

Bad Boy Mowers warrants to the original purchaser of any new Bad Boy Mower Accessory that the equipment be free from defects in material and workmanship for a period of 90 days from the date of retail sale.

At Bad Boy Mowers request, the customer will make the defective part available for inspection by Bad Boy Mowers and/or return the defective part to Bad Boy Mowers. Transportation charges prepaid.

WHAT THIS WARRANTY DOES NOT COVER:

This warranty does not cover defects caused by depreciation or damage caused by wear, accidents, improper maintenance, improper use or abuse of the product, alterations, or failure to follow the instruction contained in the Owner's Manual for operation and maintenance.

Normal maintenance service and normal replacement items such as Belts, Pulleys or normal deterioration of exterior finish due to use or exposure.

- Stitching in bags are warranted for 90 days against manufacturer defects in workmanship
- Bags are not warranted against wear.

Bad Boy Mowers will not be responsible for the pickup and delivery of a machine for warranty purposes or inspection.



WARRANTY LIMITATION:

THERE IS NO OTHER EXPRESSED WARRANTY. ANY WARRANTY THAT MAY BE IMPLIED FROM THIS PURCHASE INCLUDING MERCHANTABILITY AND FITNESS FOR A PARTICULAR PURPOSE IS HEREBY LIMITED TO THE DURATION OF THIS WARRANTY AND TO THE EXTENT PERMITTED BY LAW ANY AND ALL IMPLIED WARRANTIES ARE EXCLUDED. Some states do not allow limitations on how long an implied warranty lasts, so the above limitations may not apply to you.

BAD BOY MOWERS WILL NOT BE LIABLE FOR ANY INCIDENTAL, CONSEQUENTIAL, OR SPECIAL DAMAGES AND/OR EXPENSES IN CONNECTION WITH THE PURCHASE OR USE OF THE UNIT.

Some states do not allow the exclusion or limitation of incidental or consequential damages, so the above limitation(s) or exclusion(s) may not apply to you.

HOW TO OBTAIN SERVICE UNDER THIS WARRANTY:

Warranty service can be arranged by contacting the dealer where you purchased the mower or by contacting Bad Boy Mowers at warranty@badboymowers.com.

Proof of the date of purchase may be required to verify warranty coverage

STEP 1: Install the Bag Carrier.

- Locate the carriage bolts to be used in this portion of the installation. Remove and retain the nuts (figure 1a).
- Set one of the Carrier Supports in place. Align the corresponding holes from figure 1a and secure the brackets using the previously removed nuts and bolts. Leave the bolts just "snug" in case further adjustment is needed (figure 1b). Once installed, repeat for the other side of the mower.
- Install the Center Support into the receiver hitch (Figure 1c).
- Install the Carrier mount with the wider portion of the offset to the left of the machine as shown in (Figure 1d and 1e). Align the corresponding holes and secure it using the provided $\frac{1}{2}$ " locking nuts and the $\frac{1}{2}$ x 2 $\frac{1}{2}$ " bolt and locking nuts.
- Install the Carrier Assembly onto the Carrier Mount by sliding the receivers over the tubes and aligning the corresponding holes (Figures 1f and 1g). Secure the Carrier using the provided $\frac{1}{2}$ x $2\frac{1}{2}$ " bolts and locking nuts.
- Install the Carrier Manifold by aligning the corresponding holes and secure using the provided $\frac{1}{2}$ x $\frac{3}{4}$ " bolts and locking nuts. The tube should be pointing out and to the side as indicated in (figure 1h).

NOTE: The Canvas cover may or may not be installed, if it is not installed, do so at this stage. Align the proper snaps and push to snap. Clip the remaining edges to the frame.

- Slide the bags in place (figure 1i). Take notice that one side of the bag is a different material, this side goes toward the front of the machine.



1a



1b



1c



1d



1e



1f



1g

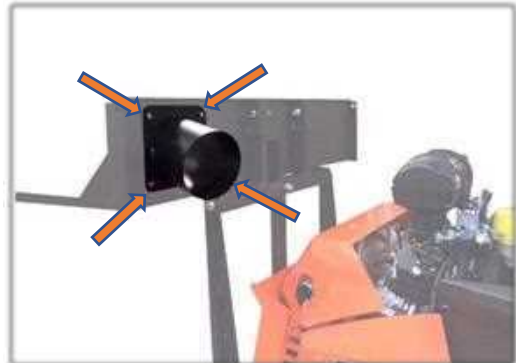

1h



1i

STEP 2: Install the Blower, Belt Tensioner, and Belt.

- Remove the rubber chute and the pulley cover (Figure 2a). Retain the nuts and bolts to be re-used.
- Remove and retain the locking nut holding the outside belt pulley. (Figure 2b)
- Install the blower pulley on top of the deck belt pulley and secure it using the locking nut previously removed. (Figure 2c).
- Install the blower mounting bracket in place of the chute bracket using the nuts and bolts previously removed. (Figure 2d).
- Identify the holes to mount the belt tensioner. Use the provided 5/16 x 1" bolts and locking nuts to secure the tensioner to the bracket. (Figure 2e and 2f)
- Route the belt through the blower pulley before mounting blower to the deck. (Figure 2g).
- Slide the blower assembly in place and secure it with the provided quick release pin. (Figure 2h and 2i)
NOTE: The blower bumper shown in 2h is either sold separately or comes in an upgraded package.
- Finish routing the belt as shown in the illustration (Figure 2j).

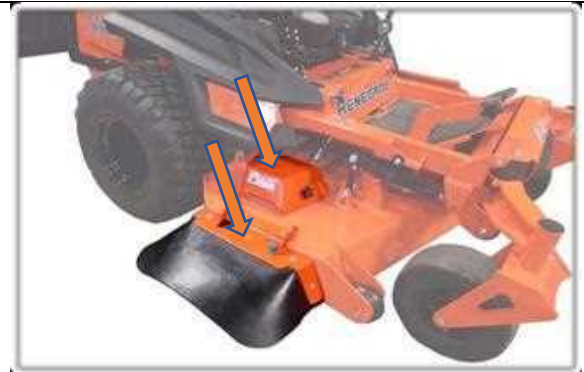

2a



2b



2c



2d



2e

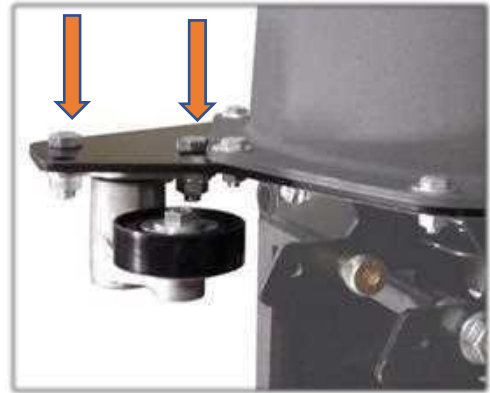

2f

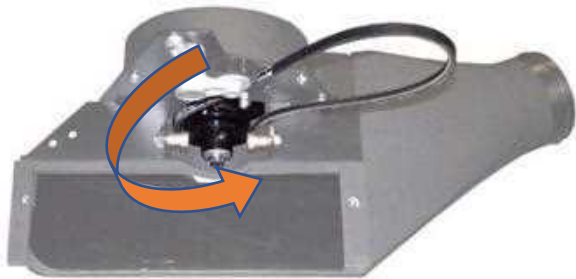

2g



2h

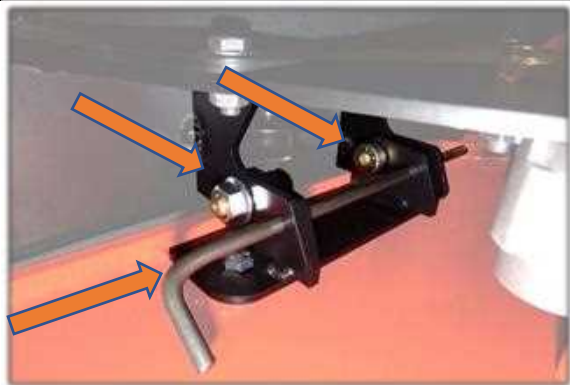

2i

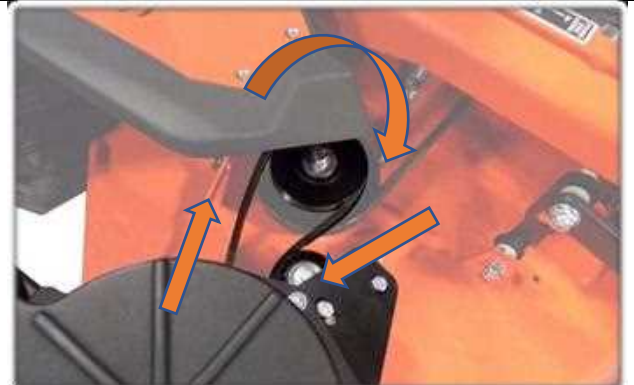

2j



2k

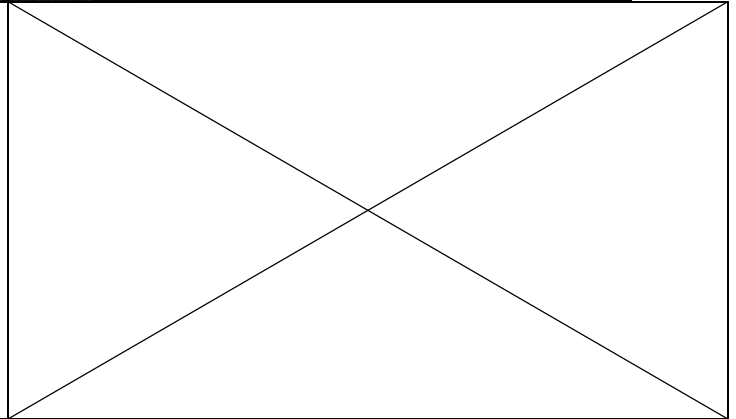

STEP 3: Install the hose.

- Attach the hose to the hose tube and secure it with the provided hose clamp (figure 3a).
- NOTE: It may be helpful to use a lubricant to assist the step (i.e. dish soap).
- Attach the hose to the blower. **The hose should be installed in a manner that it does not sag or make a hard turn. The hose should sweep up to the bagger as shown in figure 3.** On some models it is necessary to trim the hose (figure 3c).

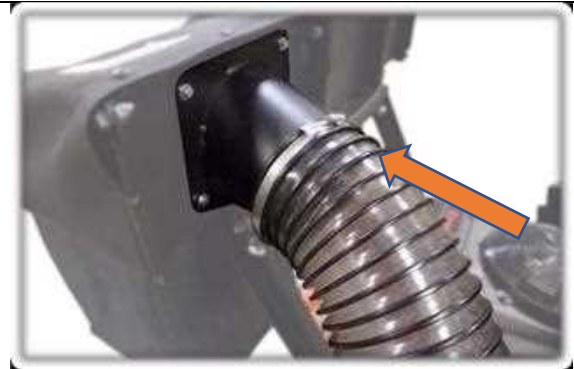

3a



3b



3c

STEP 4: Install the counterweights.

- Insert the bottom plate and tube into the front receiver and secure it with the provided hitch pin.
- Stack the weights on the bottom plate and align the corresponding holes.
- Secure the weights with the provided $\frac{1}{2}$ x $4 \frac{1}{2}$ " bolts and locking nuts.

